

REV.	ECN.NO.	DATE
A	RELEASED	04/29-'10
E	Modify NOTES	03/27-'19
F	Add Specification	08/10-'20

NOTES:

***Material**

Body: Nylon9T, UL 94V-0 Rated. Color:Black
 Contacts: Brass
 Plating: Au plating on contact area;
 Sn(100u" Min.) plating on solder tail;
 Ni(50u" Min.) underplating overall.

***Mechanical**

Insertion Force: 1.15N max per contact pair;
 Withdrawal Force: 0.15N min per contact pair;
 Contact Retention Force: 3.43N min per contact.

***Electrical Specification**

Current Rating: 1.1 Ampere;
 Contact Resistance: 30 mΩ max;
 Insulation Resistance: 1000 MΩ min;
 Dielectric Withstanding Voltage: 500 VAC.

***Environmental**

Operating Temperature: -55°C to +105°C

***How to Order:**

WPES-XXXAN91B94UWS

- S: Subtract
- W: Winning Mark
- Blank: NO Mark
- U: Lead Free
- 4: One Plastic Posts
- 9: Straddle (Short Pin With Flange T=2.0mm)
- B: Brass
- 1: Black
- N9: Nylon9T
- Au A:>0.8u" D:15u"
- Number of Contacts: 036/064/098/164
- Series NO.

	DIM 'A'	DIM 'B'	DIM 'C'	DIM 'D'	DIM 'E'	Pin 'C'
36P	7.65	25.00	6.00	12.30	8.15	A1,B17
64P	21.65	39.00	20.00	26.30	22.15	A1,B17,B31
98P	38.65	56.00	37.00	43.30	39.15	A1,B17,B31,B48
164P	71.65	89.00	70.00	76.30	72.15	A1,B17,B31,B48,B81

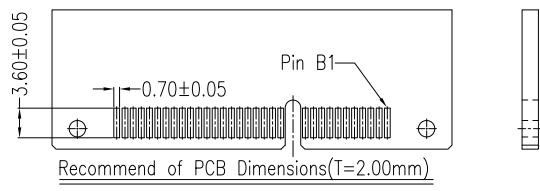
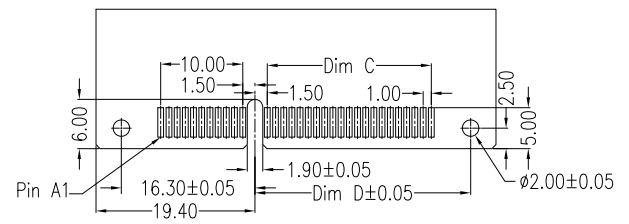
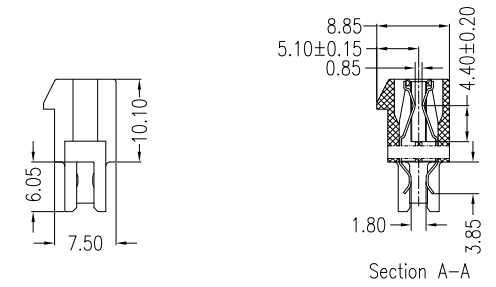
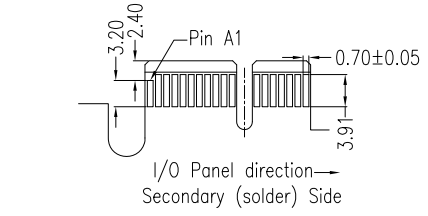
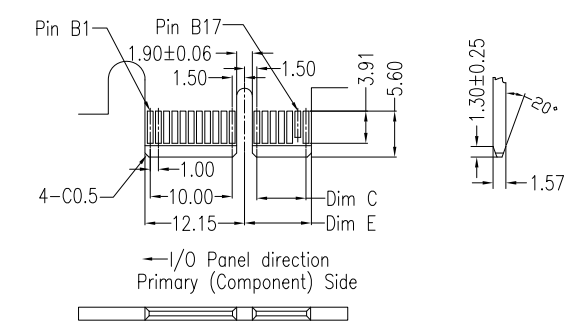
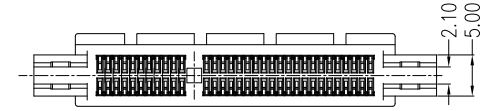
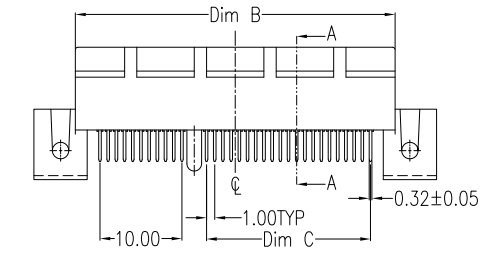
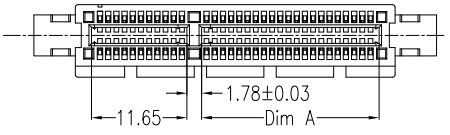
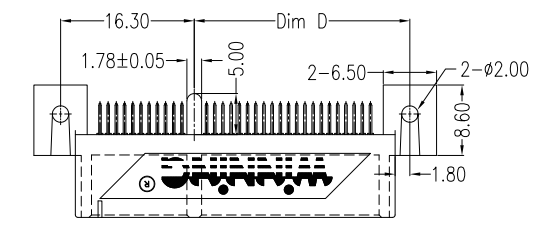

REV	Add Specification: Blank:NO Mark			Drawing By	Date	WIN WIN PRECISION IND. CO., LTD.	
Units	mm	Scale	1:1	Zk	08/10-'20	TEL: 886-2-22994155 FAX: 886-2-22994157	
Tolerance Unless Otherwise Specified				Reviewed By	Date	Date	08/10-'20
.X	~	±0.35		Lzx	08/10-'20	Sheet	1 of 1
.XX	~	±0.25		Approval By	Date	Third Angle Projection	Title
.XXX	~	±0.15		Nancy	08/14-'20		PCI Express Connector Strip Form
Angle	~	± 3°					Pin Straddle Short Pin With Flange(T=2.0mm)
						Drawing No.	WPES-XXXPS-AN-W149
						REV	F'